



DEMO BOARD TEST REPORT

Universal Input Power Factor Corrected 21W LED Driver Using KP106

FEATURES

- High PF and Low THD LED Driver Solution
- Quasi-Resonant (QR) Operation Mode with High Efficiency and Good EMI performance
- Universal Input Range with High PF>0.95
- Universal Input Range with Low THD<20%
- Fast Start-Up Speed <100ms
- Excellent Line and Load regulation <+-1%
- Built-in HV startup and IC Power supply circuit
- Leading Edge Blanking (LEB)
- LED Short and Open Protection
- Cycle-by-cycle Current Limiting
- Over Temperature Protection (OTP)

APPLICATIONS

- Commercial & Residential Lighting

DEMO BOARD SEPCIFICATION

Description	Symbol	Min	Type	Max	Unit	Note
Input Voltage	Vin	90		265	Vac	50/60Hz
Output Voltage	Vout		53	70	Vdc	OVP point is 70V
Output Current	Iout		400		mA	
Output Power	Pout			21	W	
Efficiency	η		88.0	88.4	%	Typically value tested at 230Vac/50Hz
Startup Time	Tst			100	ms	Tested at 90Vac/60Hz
Power Factor	PF	0.96				
Total Harmonics Distortion	THD			20	%	
EMI	CE/RE			Pass		EN55015
Surge				Pass		1kV Level

The table above shows the minimum acceptable performance of the design. Actual performance is listed in the results section.

Demo Board of KP106-D01-R1.1

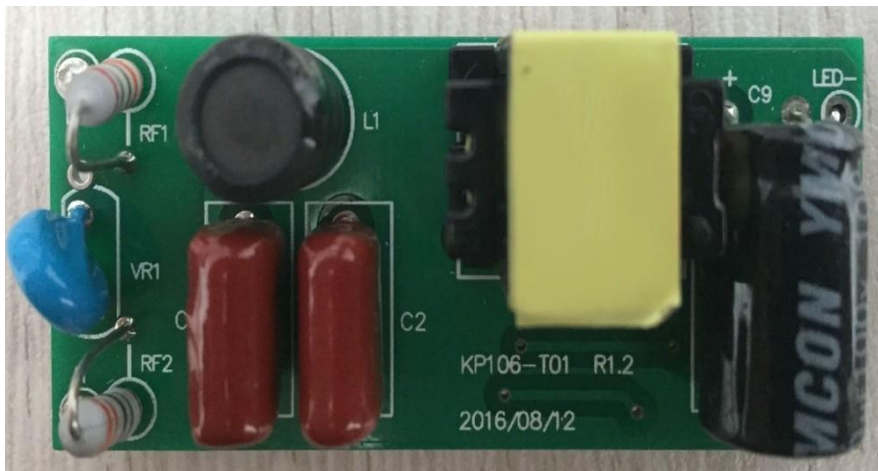

Board Size(in mm): L x W x H=57X25X17

Schematic

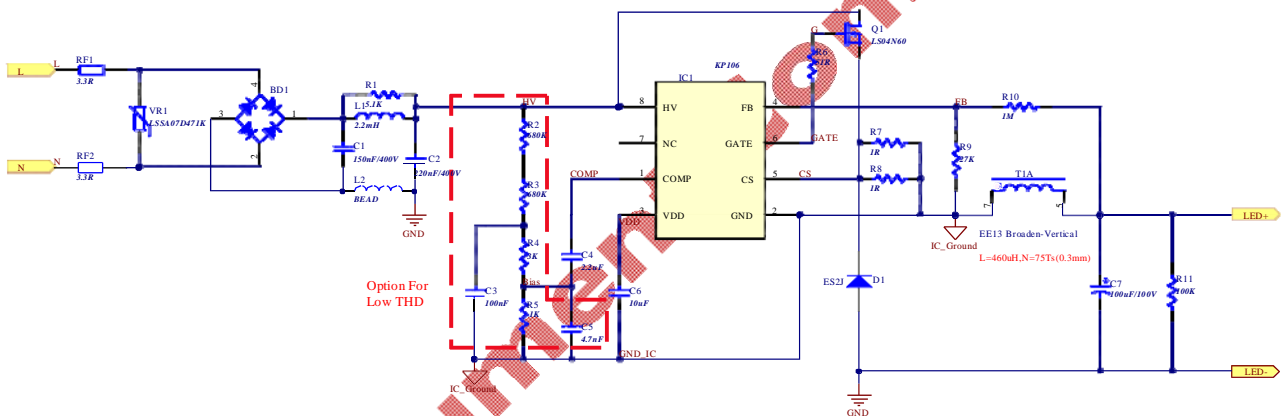

Printed Circuit Board Layout

Top Layer

Bottom Layer

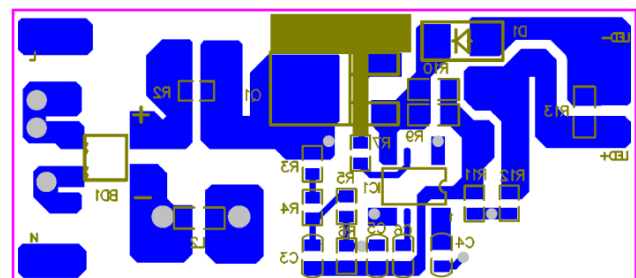
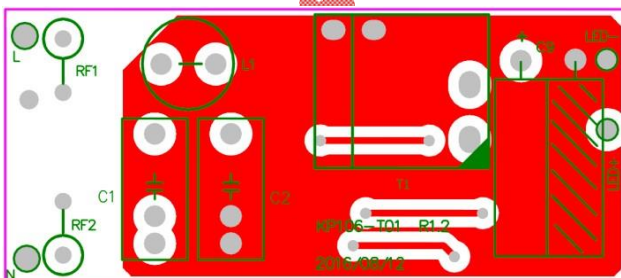

Circuit Description

The demo board of KP106-D01-R1.1 is designed with Buck topology, which adopts QR operation mode to minimize the switching loss and lead to good EMI performance. The demo board can achieve good performance for high efficiency, high power factor and accurate output current. A THD optimized circuit is adopted to achieve low THD.

1. Input Rectification and EMI filtering

The circuit input stage is composed by the components of RF1, RF2, VR1, BD1, L1, L2, C1, C2 and R1. RF1 and RF2 provide the inrush current limitation in the event of component failure or a short circuit. VR1 absorbs transient energy to protect the circuit during surge. The bridge diode of BD1 rectifies the AC input to DC output. The value of C1, C2, L1 and L2 needs to be fine-tuned according to the EMI and THD requirement.

2. KP106 Operation

KP106 is a highly integrated LED controller with constant current (CC) control for LED lighting applications. The IC utilizes Quasi-Resonant (QR) Buck topology with active PFC control for high PF, low THD, high efficiency and good EMI performance.

The VDD hold-up capacitor C6 is charged to 11V by an internal 11V regulator. When the internal power MOSFET is off, a current is drawn to the VDD capacitor from Drain pin.

C4 is compensation capacitor. Larger capacitance of C_{COMP} can provide bigger phase margin for the control loop which may make the system response slowly at the same time. R2, R3, R4, R5, C3 and C5 compose THD optimized circuit, which senses the bus voltage and offsets the compensation voltage for low THD and high PF.

R9 and R10 are used to detect zero current cross point for QR operation mode and achieve OVP. When FB pin voltage drops below 0.2V, an internal DEM comparator is triggered and a new switching cycle is initiated following the DEM triggering. The output voltage is monitored in the PWM OFF state. If the sampled voltage exceeds the OVP threshold for successive 3 cycles, the controller assumes a true OVP and it stops all switching operations. OVP is auto-recovery mode protection. In the event of LED open loop condition / OVP protection, VDD oscillation mode begins. When 8 VDD oscillation cycles had been counted, the IC will reset and start up the system again. However, if the fault still exists, the system will experience the above process. If the fault has gone, the system will resume normal operation.

R7 and R8 are used as the sensing resistor. The averaged voltage on CS pin is regulated by the IC which helps to achieve accurate output current.

Q1 is MOSFET. When Q1 is on, the energy from the source is stored in output inductor. When Q1 is off, the energy is transferred to the load. R6 is driver resistor. The resistor value needs to be tuned to balance efficiency and EMI performance.

D1 is freewheeling diode. When the internal power MOSFET is off, D1 turns on.

3. Output Filtering

T1 and C7 compose the output filtering circuit. R11 is the dummy resistor, and output capacitor is discharged after system is shut down.

Bill of Material

Num.	Designator	Value	Description	Package	Manufacturer
1	BD1	MB6S	SINGLE PHASE SILICON BRIDGE,600V/0.5A	SMD	Any
2	C1	150nF/400V	CL21,400Vdc(200Vac), P=10mm,T=6.5mm	TH	STE
3	C2	220nF/400V	C21,400Vdc,P=10mm,T=6.5mm	TH	STE
4	C3	100nF	Ceramic Cap, 25V X7R	0603	Murata
5	C4	2.2uF	Ceramic Cap, 25V X7R	0805	TDK
6	C5	4.7nF	Ceramic Cap, 50V NPO	0603	Murata
7	C6	10uF	Ceramic Cap, 25V X7R	0805	TDK
8	C7	100uF/100V	Electrolytic Cap, 100V,12.5*20	TH	Any
9	D1	ES2J	2.0 AMP Surface Mount Super Fast Recovery Rectifiers	SMA	Lision Tech
10	IC1	KP106SPA	Non-Isolated Buck APFC Offline LED Controller	SOP8	Kiwi Instrument
11	L1	2.2mH	WE-TI Inductor,Isat=0.30A, Rdc=3.30Ω,8*10	TH	Würth Elektronik
12	L2	BEAD	500Ω@100Mhz,Rdc=0.5Ω, I _{max} =300mA	1206	宝仁弘电子
13	Q1	LS4N60	N Mosfet, 600V/4A, R _{dson} =2.5ohm	TO-252	Lision Tech
14	R1	5.1K	Film Resistor, 5%	0805	Yageo
15	R2, R3	680K	Film Resistor, 5%	0805	Yageo
16	R4	3K	Film Resistor, 5%	0805	Yageo
17	R5	1K	Film Resistor, 5%	0805	Yageo
18	R6	51R	Film Resistor, 5%	0805	Yageo
19	R7, R8	1R	Film Resistor, 1%	1206	Yageo
20	R9	27K	Film Resistor, 5%	0805	Yageo
21	R10	1M	Film Resistor, 5%	0805	Yageo
22	R11	100K	Film Resistor, 5%	1206	Yageo
23	RF1	3.3R	Metal Film Power Resistor,1W	TH	Any
24	RF2	3.3R	Metal Film Power Resistor,1W	TH	Any
25	T1	460uH	EE13 Broaden, Vertical L=460uH,N=75(0.3mm)		
26	VR1	LSSA07D471 K	VARISTOR,P=5.0mm,T=4.0mm	07D	Lision Tech

Inductor Manufacture Guide

1. Electrical Diagram

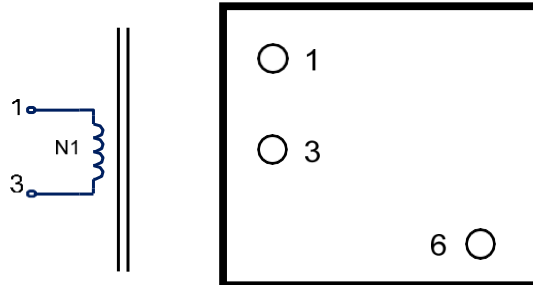

2. Winding Diagram

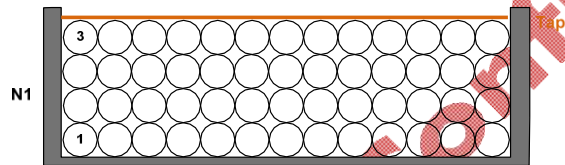

3. Winding Order

Winding Number	Layer	Start	End	Wire Size	Turns
N1	Primary	1	3	0.3d*1P	75Ts

4. Electrical Specification

Inductance	0.46mH±5% Test condition: Pins 1 - 3, measured at 40kHz, 1.0 VRMS
-------------------	--

5. Materials

Item	Description	Remark
1	Core: EE13 Broaden, PC40	
2	Bobbin: EE13 Broaden, Vertical, 10 pins, 5/5	
3	Wire: 0.30 Φ 2UEW, 130°C	
4	Tape: 3M 1350# Polyester Film	

Test Result

1. Efficiency, PF, THD and Line Regulation

Vin(VAC)	Frequency (HZ)	Pin(W)	Vout(V)	Iout(A)	Pout(W)	Efficiency	PF	THD (%)
90	50	24.41	52.8	0.392	20.70	84.79%	0.968	25.2
100		24.01	52.8	0.392	20.70	86.20%	0.978	20.2
120		23.67	52.8	0.392	20.70	87.44%	0.985	15.8
140		23.47	52.8	0.391	20.64	87.96%	0.987	13.9
160		23.31	52.8	0.390	20.59	88.34%	0.987	12.8
180		23.29	52.8	0.390	20.59	88.42%	0.986	12.3
200		23.32	52.8	0.390	20.59	88.30%	0.983	12.4
220		23.34	52.8	0.389	20.54	88.00%	0.979	12.9
240		23.39	52.8	0.388	20.49	87.59%	0.974	14.2
265		23.42	52.6	0.388	20.41	87.14%	0.966	16.2

Efficiency

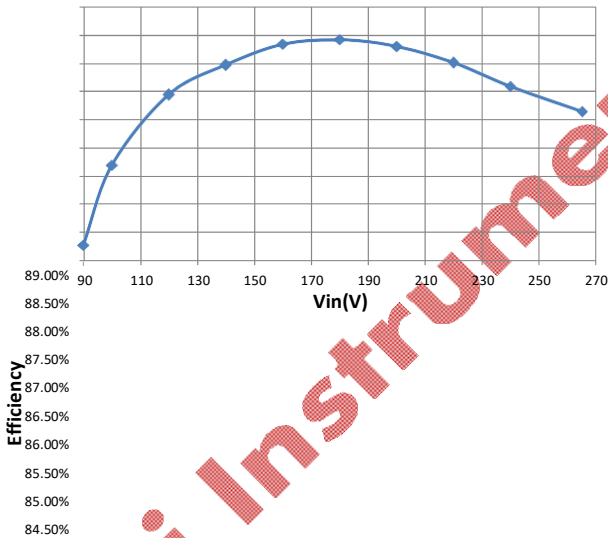

ILED

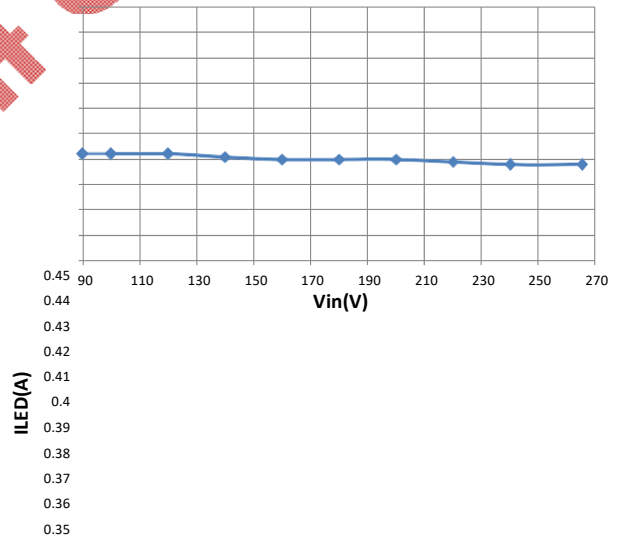

THD

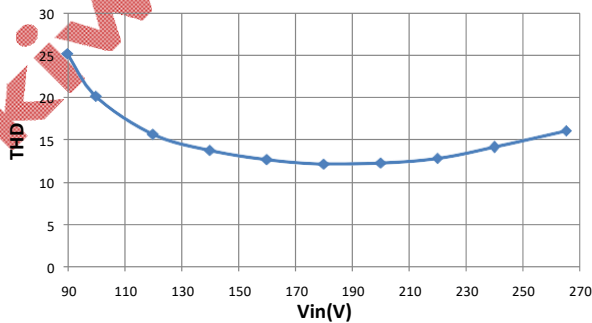

Power Factor

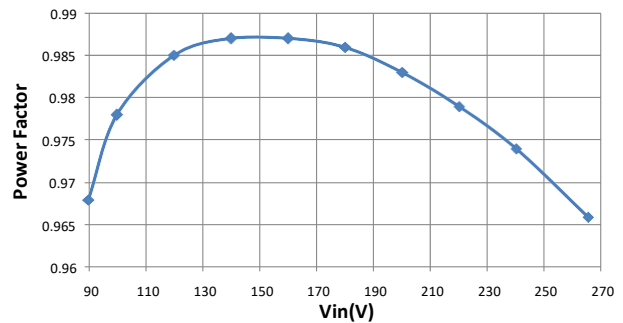

2. Load Regulation

	Vout (V)	43.5	46.7	49.8	52.7	55.7	58.7	61.8
120Vac/60Hz	Iout (A)	0.391	0.391	0.391	0.391	0.391	0.391	0.391
230Vac/50Hz	Iout (A)	0.388	0.388	0.388	0.388	0.388	0.388	0.388

Demo Board Test Report

Universal Input Power Factor Corrected 21 W LED Driver Using KP106

3. EMC Test Result (Test Condition: Vin=110VAC/60Hz, Vout=53V, Io=400mA)

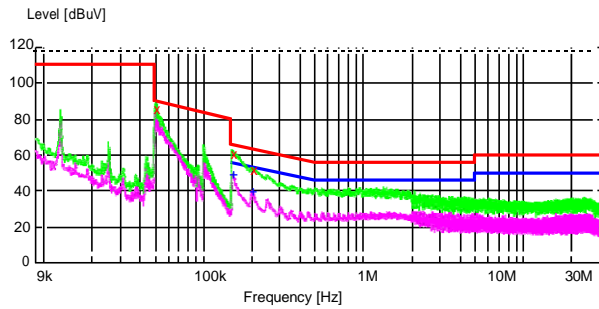

Conduction EMI---LINE

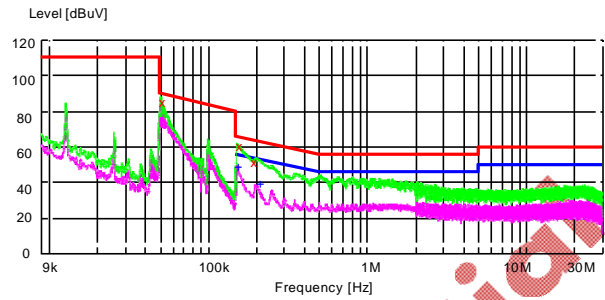

Conduction EMI---NEUTRAL

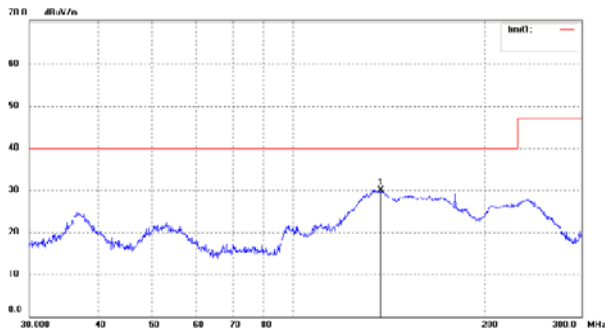

Radiation EMI---HORIZONTAL

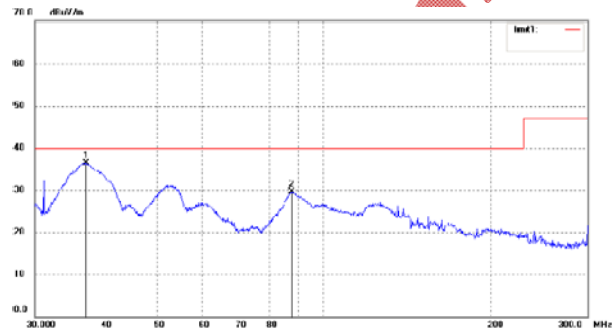

Radiation EMI---VERTICAL

4. EMC Test Result (Test Condition: Vin=230VAC/50Hz, Vout=53V, Io=400mA)

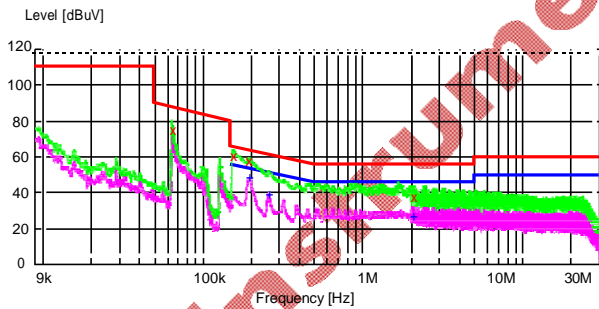

Conduction EMI---LINE

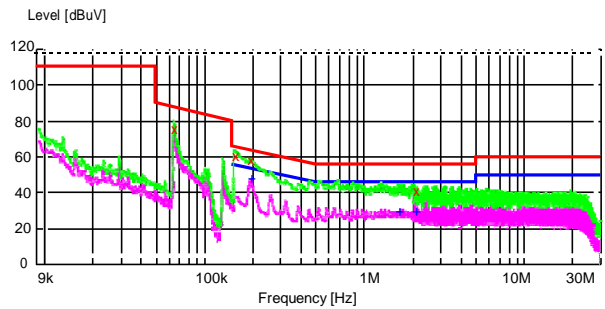

Conduction EMI---NEUTRAL

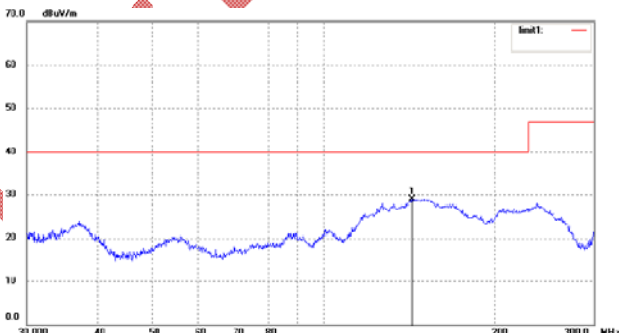

Radiation EMI---HORIZONTAL

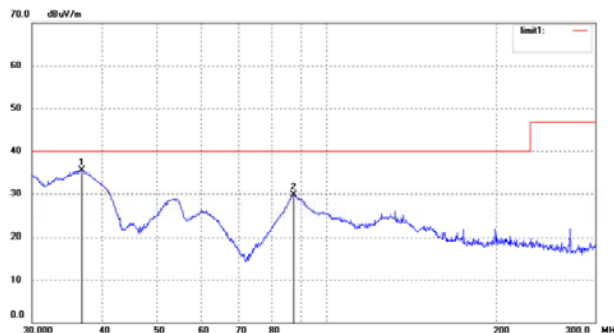

Radiation EMI---VERTICAL

9. Operation Curves (Test Condition: Vin=120VAC/60Hz, Vout=53V, Io=400mA)

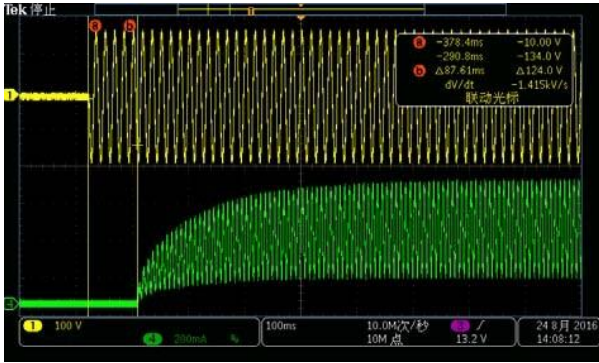

System Startup Time
(CH1-VINAC, CH4-LED Current)



System Shut Down
(CH1-VINAC, CH4-LED Current)

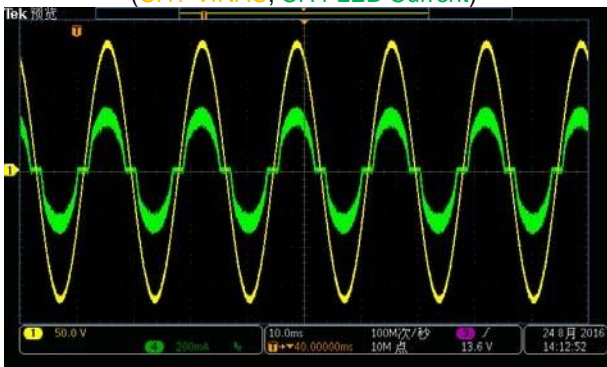

System Steady State
(CH1-VINAC, CH4-AC Current)

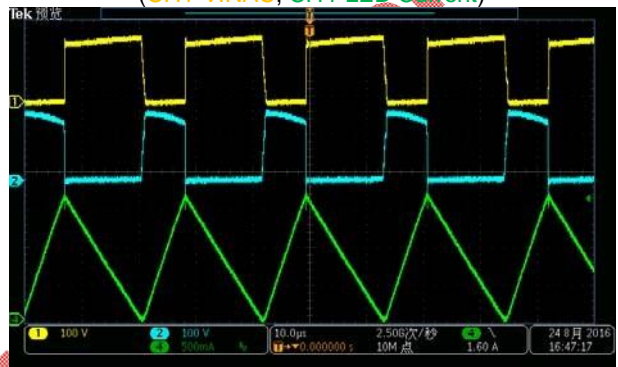

System Steady State
(CH1-V_MOS, CH2-V_Diode, CH4-Inductor Current)



LED Short Fault Happen
(CH1-VDD, CH3-VLED, CH4- Inductor Current)



LED Short Fault Recovery
(CH1-VDD, CH3-VLED, CH4- Inductor Current)

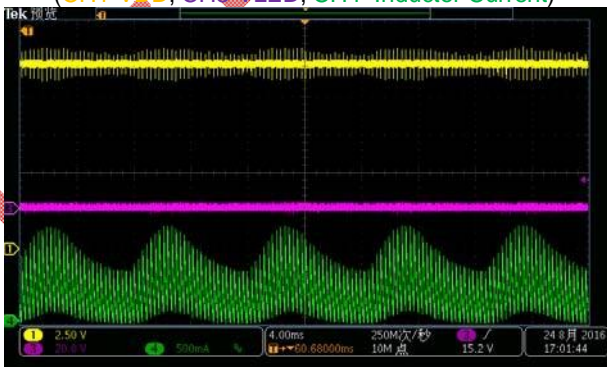

LED Short Fault Steady State
(CH1-VDD, CH3-VLED, CH4-Inductor Current)

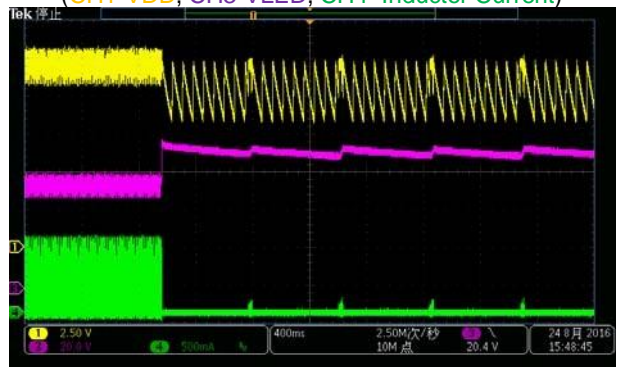

LED Open Fault Happen
(CH1-VDD, CH3-VLED, CH4-Inductor Current)

6. Operation Curves (Test Condition: $V_{in}=230VAC/50Hz$, $V_{out}=53V$, $I_o=400mA$)

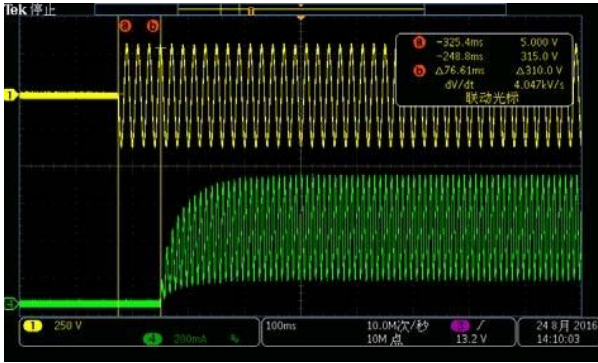

System Startup Time
(CH1-VINAC, CH4-LED Current)



System Shut Down
(CH1-VINAC, CH4-LED Current)

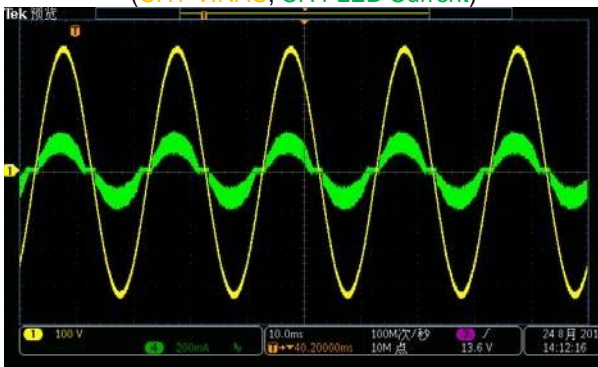

System Steady State
(CH1-VINAC, CH4-AC Current)

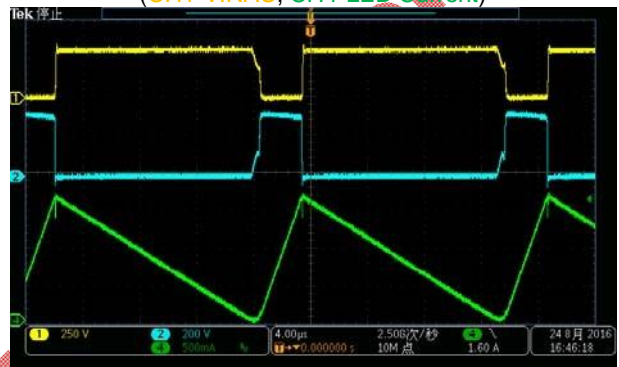

System Steady State
(CH1-V_MOS, CH2-V_Diode, CH4- Inductor Current)



LED Short Fault Happen
(CH1-VDD, CH3-VLED, CH4- Inductor Current)

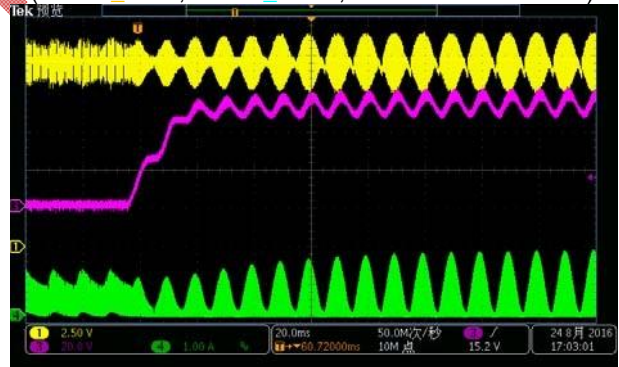

LED Short Fault Recovery
(CH1-VDD, CH3-VLED, CH4- Inductor Current)



LED Short Fault Steady State
(CH1-VDD, CH3-VLED, CH4- Inductor Current)

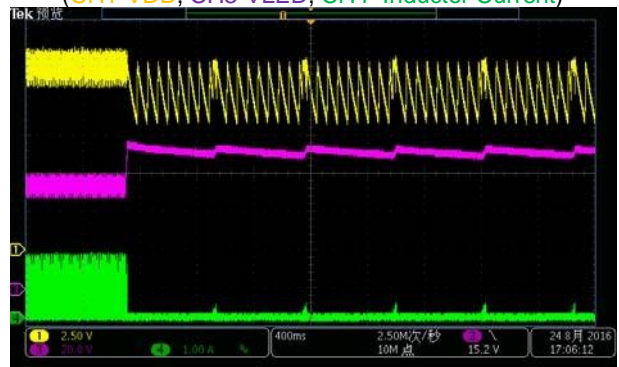

LED Open Fault Happen
(CH1-VDD, CH3-VLED, CH4- Inductor Current)

Test Setup Guide

1. Connect the “LED+” terminal to the anode of LED string and the “LED-” terminal to the cathode of LED string.
2. Set the AC Power Source to between 90VAC and 265VAC.
3. Connect the AC Power Source terminal to the “L” and “N” terminals on the Demo Board.
4. Turn on the AC Power Source to make system startup; and Turn off the AC Power Source to make system shutdown.

Kiwi Instrument Confidential



Revision History

DATE	REV.	DESCRIPTION
2016-08-24	1.0	First Release
2016-11-11	1.01	Add Inductor Manufacture Materials, Update Demo Board picture

Contact Us:

US (Headquarter):

Add: 2060 Walsh Ave, Suite 244,
Santa Clara, CA, 95050
Tel: 1-408-475-6888
Fax: 1-408-905-6912
E-mail: marketing@kiwiinst.com

Hangzhou (R&D Center):

Add: Room 1205, Building C, No.581
HuoJu Road, Binjiang Dist. Hangzhou,
P.R.C
Tel: (86) 571-8795-8612
Fax: (86) 571-8795-5363
E-mail: marketing@kiwiinst.com.cn

Shenzhen (Marketing/Field Support):

Add: B302-B303, University
Creative Park, Xili Rd., Nanshan
District, Shenzhen, P.R.C
Tel: (86)755-8204-2689
Fax: (86)755-8204-2192
E-mail: marketing@kiwiinst.com.cn

Disclaimer

Information that is provided by Kiwi Instruments Corporation is believed to be accurate and reliable. Kiwi instrument reserves the right to make any change in circuit design, specification or other related things if necessary without notice at any time. No third party intellectual property infringement of the applications should be guaranteed by users when integrating Kiwi instrument products into any application. No legal responsibility for any said applications is assumed by Kiwi Instrument.